

# LE-376

---

## 3.5 Miniboard

### User's Manual

Edition 1.1

2011/11/17





## **Copyright**

Copyright 2010. All rights reserved. This document is copyrighted and all rights are reserved. The information in this document is subject to change without prior notice to make improvements to the products.

This document contains proprietary information and protected by copyright. No part of this document may be reproduced, copied, or translated in any form or any means without prior written permission of the manufacturer.

All trademarks and/or registered trademarks contains in this document are property of their respective owners.

## **Disclaimer**

The company shall not be liable for any incidental or consequential damages resulting from the performance or use of this product.

The company does not issue a warranty of any kind, express or implied, including without limitation implied warranties of merchantability or fitness for a particular purpose.

The company has the right to revise the manual or include changes in the specifications of the product described within it at any time without notice and without obligation to notify any person of such revision or changes.

## **Trademark**

All trademarks are the property of their respective holders.

---

Any questions please visit our website at <http://www.commell.com.tw>

## Packing List:

Please check the package content before you starting using the board.

### Hardware:

LE-376 "3.5 Miniboard" x 1

### Cable Kit:



DC Power Cable x 1  
(OALDC-2)



SATA Cable x 1  
(OALSATA-L)



CN\_PS2 Cable x 1  
(OALPS2/KM)



1 to 3 power output cable x 1  
(OAL4P-2)



COM Port Cable x 1  
(OALES-BKU1NB)

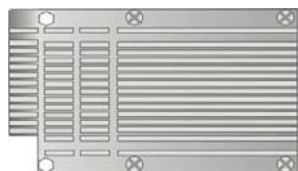

Heatsink x 1  
LE-376G & LE-3769  
(OHS-376)



Audio Cable x 1  
(OALPJ-HDUNB)



Dual COM PORT cable x 1  
(OALES-BKU2NB)

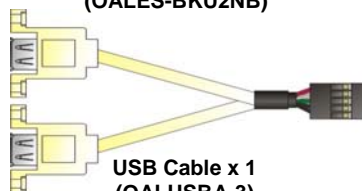

USB Cable x 1  
(OALUSBA-3)



Heatsink x 1  
LE-376A & LE-376C & LE-376H  
(OHS-376F)

### Optional:

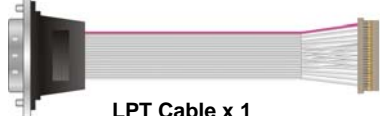

LPT Cable x 1  
(OALLPT-DF-14)

### Printed Matters:

Driver CD x 1 (Including User's Manual)

## Index

<b>Chapter 1 &lt;Introduction&gt;</b> .....	<b>5</b>
1.1 <Product Overview> .....	5
1.2 <Product Specification>.....	6
1.3 <Mechanical Drawing> .....	8
1.4 <Block Diagram> .....	9
<b>Chapter 2 &lt;Hardware Setup&gt;</b> .....	<b>10</b>
2.1 <Connector Location> .....	10
2.2 <Jumper Reference>.....	12
2.3 <Connector Reference> .....	13
2.3.1 <Internal Connector> .....	13
2.3.2 <External Connector> .....	13
2.4 <CPU and Memory Setup> .....	14
2.5 <CMOS & ATX Setup> .....	15
2.6 <CF Interface>.....	16
2.7 <Serial ATA Interface> .....	17
2.8 <LAN Interface> .....	18
2.9 <Onboard Display Interface> .....	19
2.9.1 <Analog VGA Interface>.....	19
2.9.2 <Digital Display>.....	20
2.10 <Onboard Audio Interface> .....	24
2.11 <USB2.0 Interface> .....	25
2.12 <Serial Port Jumper Setting > .....	26
2.13 <Power & FAN Connector > .....	29
2.13.1 <Power Input>.....	29
2.13.2 <Power Output> .....	30
2.13.3 <Fan Connector>.....	31
2.14 <Indicator and Switch> .....	32
<b>Chapter 3 &lt;BIOS Setup&gt;</b> .....	<b>33</b>
<b>Appendix A &lt;I/O Port Pin Assignment&gt;</b> .....	<b>34</b>

A.1 <LPT Port> .....	34
A.2 <CRT Port > .....	34
A.3 <LAN Port>.....	35
A.4 <IrDA Port>.....	35
A.5 <SMBUS Port>.....	35
A.6 <Serial Port> .....	36
A.7 <DIO Port> .....	36
A.8 <PS2 Port>.....	36
<b>Appendix B &lt;Flash BIOS&gt;.....</b>	<b>37</b>
B.1 BIOS Auto Flash Tool .....	37
B.2 Flash Method.....	37
<b>Appendix C &lt;System Resources&gt; .....</b>	<b>38</b>
C.1 <Direct memory access(DMA)> (LE-376A) .....	38
C.2<Input/output(IO)> (LE-376A) .....	38
C.3<Interrupt request(IRQ)> (LE-376A) .....	40
C.4<Memory> (LE-376A) .....	41
<b>Appendix E &lt;Watch Dog timer Setting &gt; .....</b>	<b>42</b>
<b>Contact Information.....</b>	<b>43</b>

# Chapter 1 <Introduction>

## 1.1 <Product Overview>

LE-376G/9/H/A/C is the 3.5 miniboard, with Intel® Atom N450/N455/D410/D510/D525 processor, integrated GMA3150 graphics, Intel® ICH8M, DDR2 SO-DIMM memory, Realtek HD Audio, CF, SATAII, LVDS, LPT, IrDA, DIO, USB, CN\_PS2, DC\_OUT, SMBUS, CN\_INV and Intel® 82583V Gigabit LAN.

### **Intel® Atom Processor**

The Intel® Atom N450/N455/D410/D510/D525 processor supports one channel of 667 MHz DDR2 SDRAM up to 2GB/2GB/4GB/4GB/4GB. The chipset features power-efficient graphics with an integrated 18-bit 3D graphics engine based on Intel® Graphics Media Accelerator 3150 architecture with LVDS, CRT display ports. The DMI is designed into the Pineview-M(D) processor to provide an efficient high-bandwidth communication channel between the processor and the ICH8M.

### **Embedded Intel® ICH8M**

The board integrates Intel® ICH8M. It provides I/O capabilities and flexibility via high-bandwidth interfaces such as PCIE and Hi-Speed USB 2.0 connectivity. Serial ATA. HD Audio, Mini PCI, CF, LAN.

### **Flexible Extension Interface**

The board also provides Compact Flash Type II socket and one PCIE mini card socket.

## 1.2 <Product Specification>

### General Specification

Form Factor	3.5 miniboard
CPU	Intel® Atom N450 processor 1.66GHz (LE-376G, No fans) Intel® Atom N455 processor 1.66GHz (LE-3769, No fans) Intel® Atom D410 processor 1.66GHz (LE-376H, A fan) Intel® Atom D510 processor 1.66GHz (LE-376A, A fan) Intel® Atom D525 processor 1.80GHz (LE-376C, A fan) Package type: FCBGA559
Memory	1 x 200-pin DDR2 SO-DIMM 667MHz SDRAM up to 2GB (LE-376G/9 Only) 1 x 200-pin DDR2 SO-DIMM 667MHz SDRAM up to 4GB (LE-376H/A/C Only) Unbuffered, none-ECC memory supported only
Chipset	Intel® ICH8M
BIOS	Phoenix-Award v6.00PG 8Mb SPI flash BIOS
Power Management	ACPI 2.0 compliant , supports power saving mode
Watchdog Timer	System reset programmable watchdog timer with 1 ~ 255 sec./min. of timeout value
Real Time Clock	Intel® ICH8M built-in RTC with lithium battery
Integrated Graphics	Intel® integrated extreme GMA 3150(Graphic Media Accelerator) Technology
Serial ATA	2 x Serial ATAI interfaces(Up to 300MB/s of transfer rate)
Video Memory	Up to 384MB shared with system memory
LVDS interface	Chipset Integrated 18-bit single channel LVDS with Hirose connector with +3.3V/5V supply
Solid State Disk	1 x Compact Flash Type II socket
Audio Interface	Intel ICH8M integrated with Realtek ALC888 HD Codec
LAN Interface	Intel 82583V Gigabit Ethernet controller
Extended Interface	1 x PCIE Mini card socket , 1 x Mini PCI socket to support Mini PCI Type III B
Internal I/O Port	1 x RS232/RS422/485 , 4 x RS232 , 1 x LVDS , 1 x CN_INV , 1 x LPT , 1 x IrDA , 4 x USB2.0 , 2 x SATAII , 1 x SMBUS , 1 x DC_OUT , 1 x CN_PS2 , 1 x DIO and 1 x HD Audio
External I/O Port	3 x RJ45 , 1 x USB , 1 x VGA port , 1 x RS232 port
Power Requirement	9~24V DC Input
Dimension	146mm x 101mm
Temperature	Operating within 0~60 centigrade Storage within -20~85 centigrade

### Ordering Code

LE-376G	Support Intel® Atom <b>N450</b> processor with onboard VGA, LVDS for 18bit, Audio, Giga LAN, USB2.0, CF, PCIE mini card
LE-3769	Support Intel® Atom <b>N455</b> processor with onboard VGA, LVDS for 18bit, Audio, Giga LAN, USB2.0, CF, PCIE mini card
LE-376H	Support Intel® Atom <b>D410</b> processor with onboard VGA, LVDS for 18bit, Audio, Giga LAN, USB2.0, CF, PCIE mini card
LE-376A	Support Intel® Atom <b>D510</b> processor with onboard VGA, LVDS for 18bit, Audio, Giga LAN, USB2.0, CF, PCIE mini card
LE-376C	Support Intel® Atom <b>D525</b> processor with onboard VGA, LVDS for 18bit, Audio, Giga LAN, USB2.0, CF, PCIE mini card

The specifications may be different as the actual production.

For further product information please visit the website at <http://www.commell.com.tw>

### 1.3 <Mechanical Drawing>

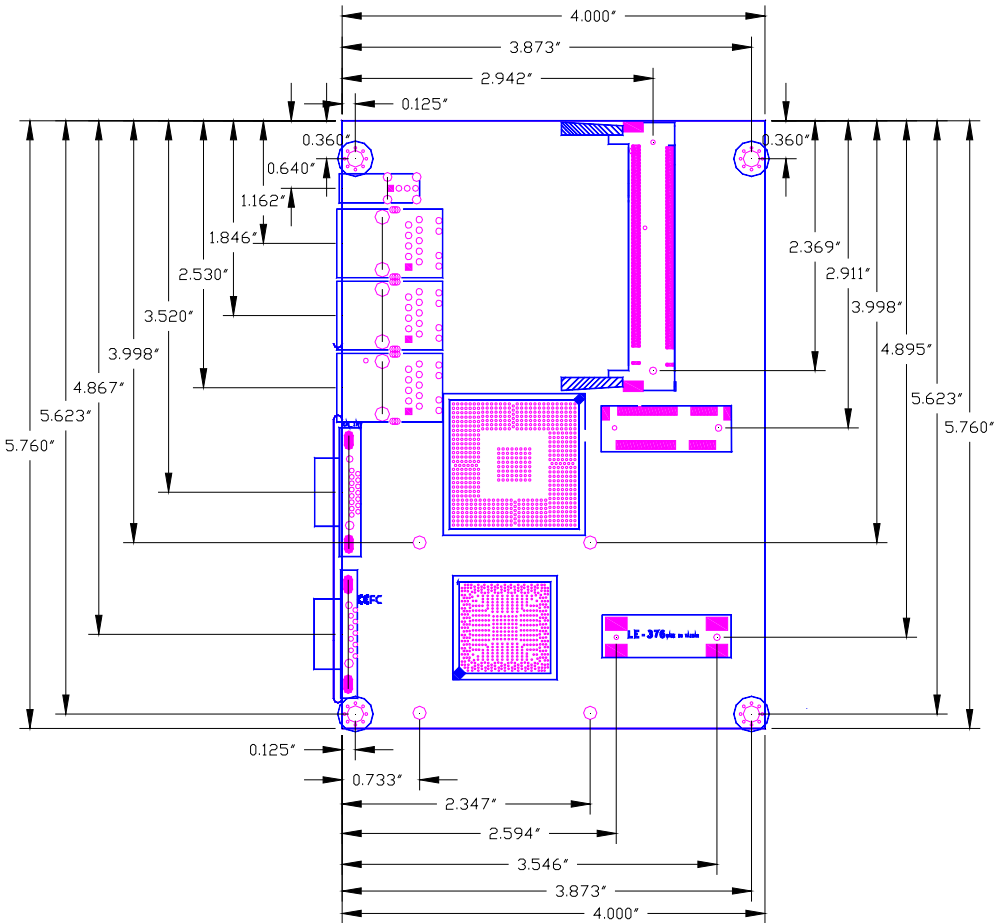

# 1.4 <Block Diagram>

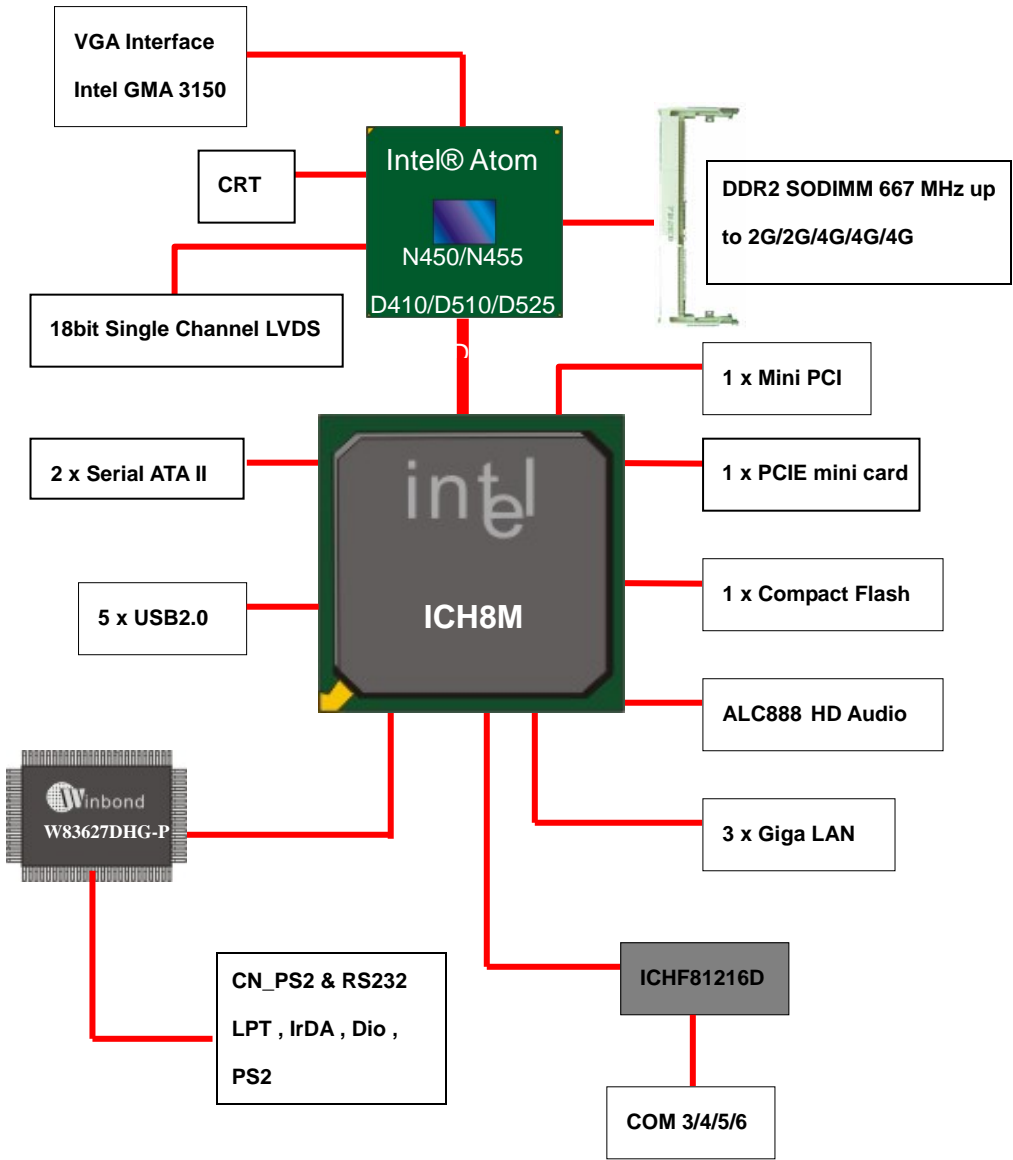

## Chapter 2 <Hardware Setup>

### 2.1 <Connector Location>

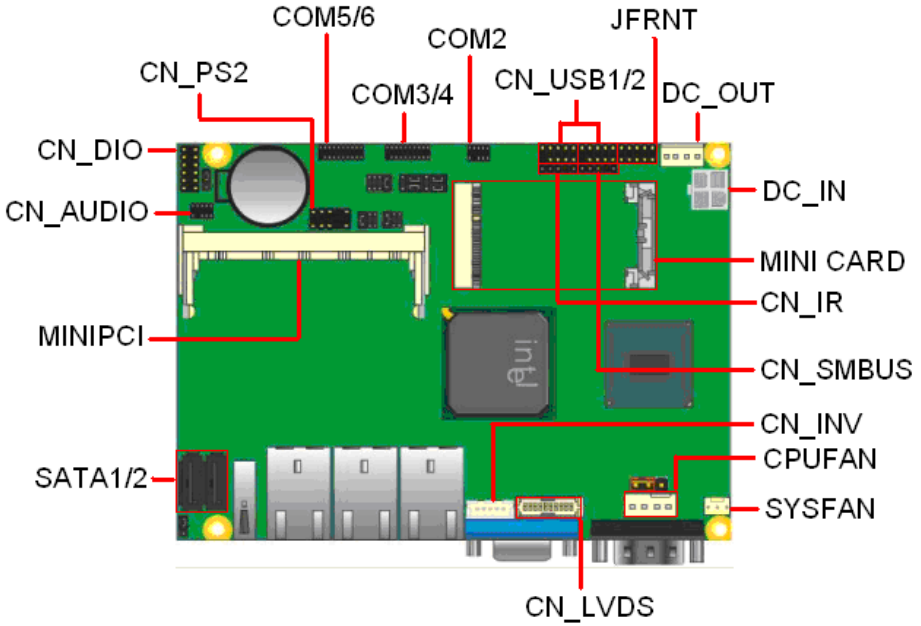

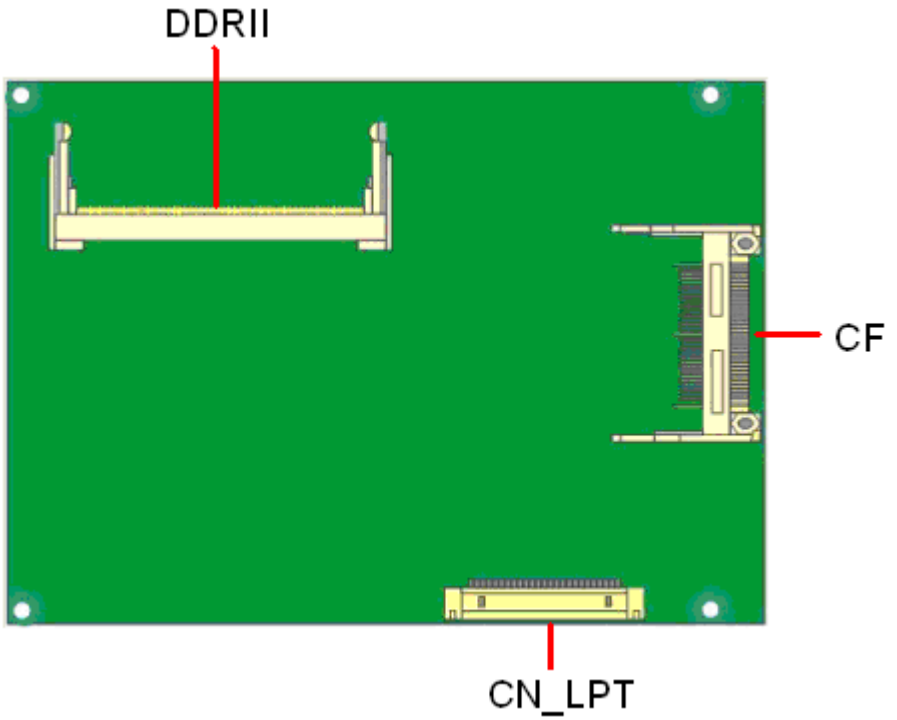

## LE-376G/9/H/A/C

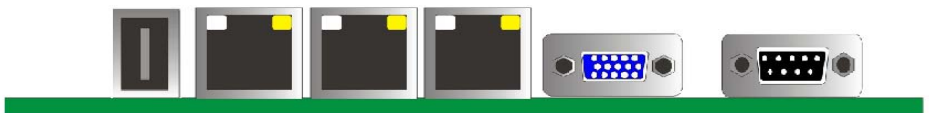

## 2.2 <Jumper Reference>

Jumper	Function
JRTC	CMOS Operating/Clear Setting
JVLCD	Panel Voltage Setting
JAT	Power mode select
JCSEL1	CN_COM2 RS-232 RS422 RS485 Setting / CN_IR IrDA Setting
JCSEL2	Setting
JP1	CN_COM3/4/5/6 RS-232
JP2	

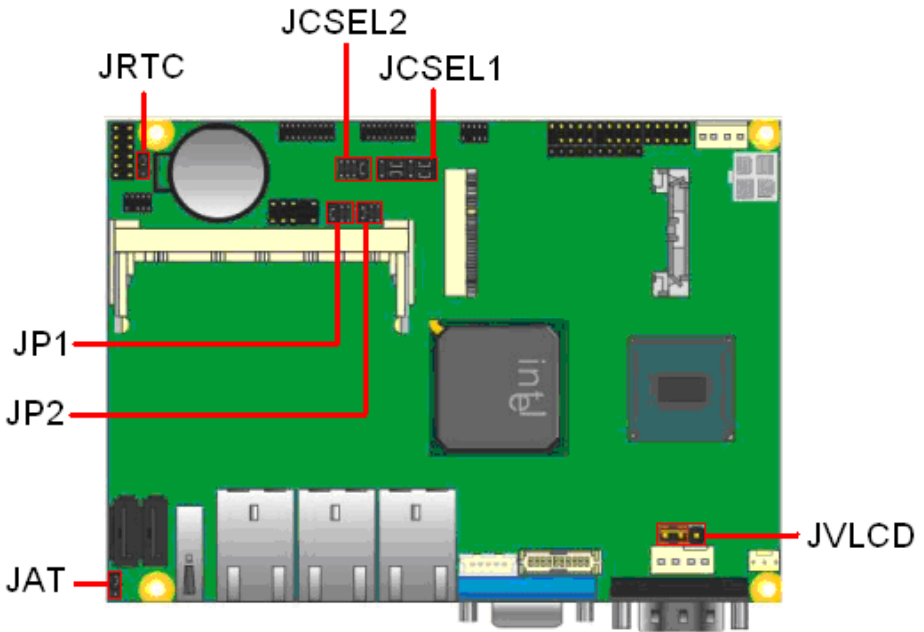

## 2.3 <Connector Reference>

### 2.3.1 <Internal Connector>

Connector	Function	Remark
DDRII	200 –pin DDR2 SO-DIMM SDRAM slot	
SATA1/2	7-pin Serial ATA connector	
CF	Compact Flash Type II socket	
MINI_CARD	PCIE mini card socket	
CN_LVDS	10 x 2-pin LVDS connector	
CN_INV	5-pin LCD inverter connector	
CN_USB1/2	5 x 2-pin USB connector	
CN_AUDIO	5 x 2-pin audio connector	
CN_COM2	5 x 2-pin com connector	
CN_COM3/4/5/6	10 x 2-pin com connector	
JFRNT	10-pin switch/indicator connector	
FAN	3-pin system cooler fan connector	
DC_OUT	4-pin power output connector	
DC_IN	DC 12V input connector	
CN_LPT	25-pin LPT connector	
CN_DIO	6 x 2-pin digital I/O connector	
CN_IR	5-pin IrDA connector	
MINIPCI	124-pin Mini PCI socket Type IIIA	
MINI_CARD	52-pin PCI Express mini card	
JCSEL1	CN_COM2 RS-232 RS422 RS485	
JCSEL2	Setting / CN_IR IrDA Setting	
JRTC	CMOS Operating/Clear Setting	
CN_PS2	5 x 2-pin PS2 connector	
CN_SMBUS	5-pin SMBUS connector	
JAT	Power mode select	
JRTC	CMOS Operating/Clear Setting	

### 2.3.2 <External Connector>

Connector	Function	Remark
CRT	DB15 VGA connector	
USB	USB keyboard and mouse connector	
RJ45	RJ45 LAN connector	
COM1	DB9 RS232 COM Port	

## 2.4 <CPU and Memory Setup>

Non-ECC, unbuffered memory is supported only.

**LE-376G/9** provides one 200-pin DDR2 SO-DIMM to support DDR2 667 memory modules support up to 2GB of capacity.

**Suggestion:**

DDR2 SO-DIMM Modules:

- Raw Card A = 2 Ranks of x16 SDRAMs (Double-sided)
- Raw Card C = 1 Rank of x16 SDRAMs (Single-sided)

**LE-376H/A/C** provides one 200-pin DDR2 SO-DIMM to support DDR2 667 memory modules support up to 4GB of capacity.

**Suggestion:**

DDR2 SO-DIMM Modules:

- Raw Card C = 1 Rank of x16 SDRAMs (Single -sided)
- Raw Card D = 1 Rank of x8 SDRAMs (Single-sided)
- Raw Card E = 2 Ranks of x8 SDRAMs (Double -sided)

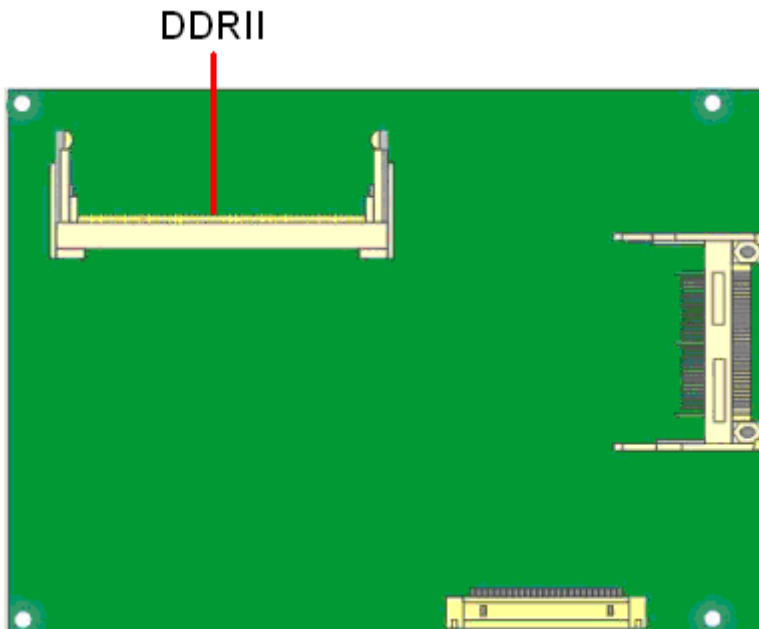

## 2.5 <CMOS & ATX Setup>

The board's data of CMOS can be setting in BIOS. If the board refuses to boot due to inappropriate CMOS settings, here is how to proceed to clear (reset) the CMOS to its default values.

Jumper: **JRTC**

Type: Onboard 3-pin jumper

JRTC	Mode
1-2	Clear CMOS
2-3	Normal Operation

Default setting

Jumper: **JAT**

Type: onboard 3-pin jumper

JAT	Mode
1-2	AT Mode
2-3	ATX Mode

Default setting

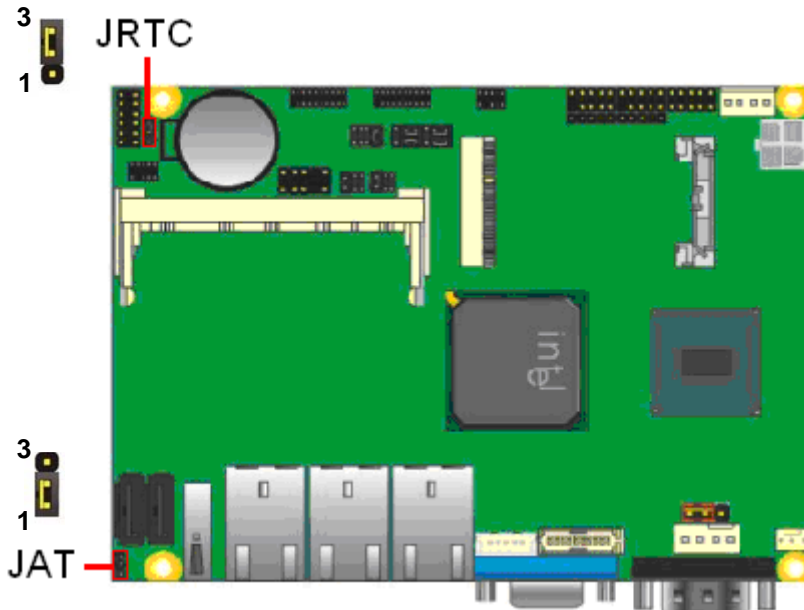

## 2.6 <CF Interface>

The board has one Compact Flash Type II socket on the solder side.

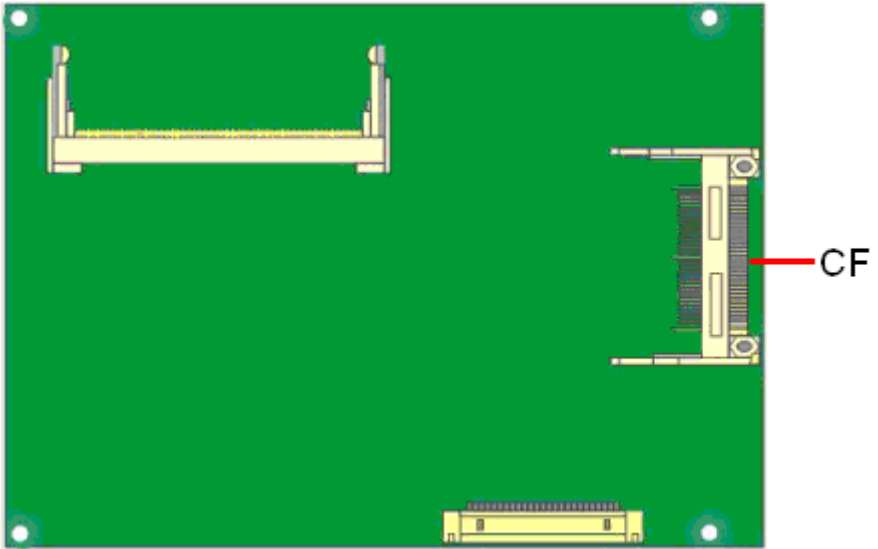

## 2.7 <Serial ATA Interface>

Based on Intel ICH8M, the board provides one Serial ATAII interfaces with up to 300MB/s of transfer rate.

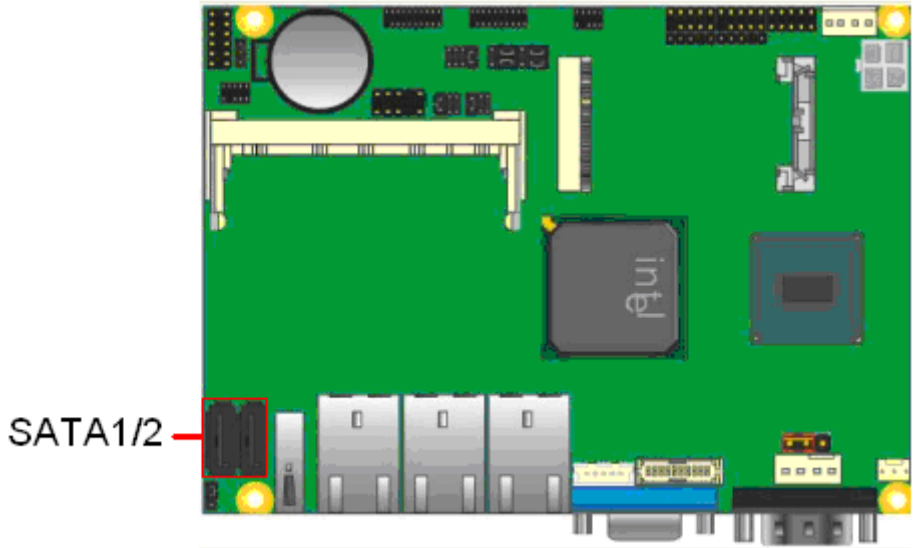

## 2.8 <LAN Interface>

The Intel® 82583v supports triple speed of 10/100/1000Base-T, with IEEE802.3 compliance.



## 2.9 <Onboard Display Interface>

Based on Intel® Atom N450/N455/D410/D510/D525 with built-in GMA (Graphic Media Accelerator) 3150 graphics, the board provides one DB15 on real external I/O port, and one 20-pin LVDS interface with 5-pin LCD backlight inverter connector. The board provides dual display function with clone mode and extended desktop mode for CRT and LVDS.

### 2.9.1 <Analog VGA Interface>

Please connect your CRT or LVDS monitor with DB15 male connector to the onboard DB15 female connector on rear I/O port.

LE-376G/9 supports 1400 x 1050 (WUXGA) resolution displays.

LE-376H/A/C supports 2048 x 1536 (WUXGA) resolution displays.

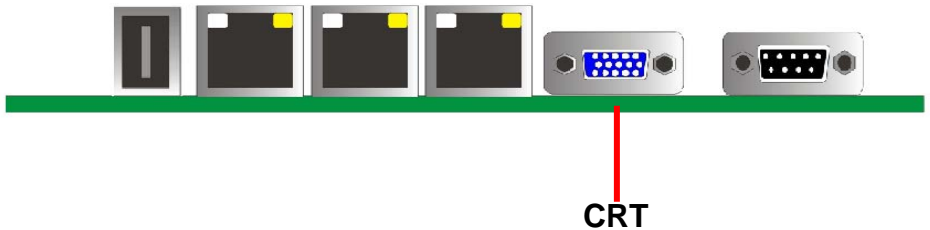

## 2.9.2 <Digital Display>

The board provides one 20-pin LVDS connector for 18 bit single channel panels, LE-376G/9 supports 1280 x 800 (WUXGA) resolution displays.

LE-376H/A/C supports 1366 x 768 (WUXGA) resolution displays, with one LCD backlight inverter connector and one jumper for panel voltage setting

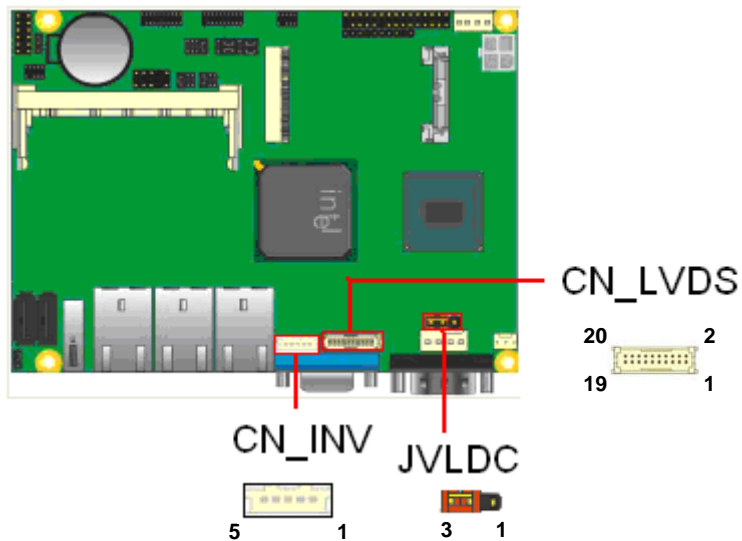

Connector: **CN\_INV**

Type: 5-pin Inverter power connector

Connector model: **molex\_53261-5pin**

Pin	Description
1	+12V
2	GND
3	GND
4	GND
5	ENABKL

Jumper: **JVLCD**

Type: 3-pin Power select jumper

Pin	Description
1-2	+5V
2-3	+3.3V

**Default: 2-3**

Connector: **CN\_LVDS**

Type: onboard 20-pin connector for LVDS connector

Connector model: **HIROSE DF13-20DP-1.25V**

Pin	Signal	Pin	Signal
2	LCDVCC	1	LCDVCC
4	GND	3	GND
6	TXL0P	5	TXL0N
8	TXL1N	7	GND
10	GND	9	TXL1P
12	TXL2P	11	TXL2N
14	TXLCKN	13	GND
16	GND	15	TXLCKP
18	SMBDATA	17	SMBCLK
20	SPDIFO	19	GND

## LE-376 User's Manual

To setup the LCD, you need the component below:

1. A panel with LVDS interfaces.
2. An inverter for panel's backlight power.
3. A LCD cable and an inverter cable.

For the cables, please follow the pin assignment of the connector to make a cable, because every panel has its own pin assignment, so we do not provide a standard cable; please find a local cable manufacture to make cables.

### LCD Installation Guide:

1. Preparing the LE-376, LCD panel and the backlight inverter

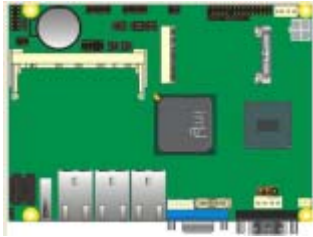

2. Please check the datasheet of the panel to see the voltage of the panel, and set the jumper **JVLCD** to +5V or +3.3V.
3. You would need a LVDS type cable.

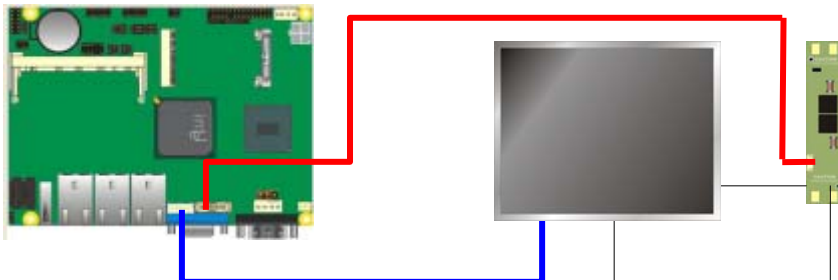

After setup the devices well, you need to select the LCD panel type in the BIOS.



The panel type mapping is list below:

LE-376 BIOS panel type selection form	
On board Single channel LVDS	
18bit	
NO.	Output format
1	640 x 480
2	800 x 480
3	800 x 600
4	1024 x 600
5	1024 x 768
6	1280 x 768

## 2.10 <Onboard Audio Interface>

The board provides the onboard high definition audio with Realtek ALC888

**Connector: CN\_AUDIO**

Type: 10-pin (2 x 5) 1.27mm x 2.54mm-pitch header

Pin	Description	Pin	Description
1	MIC2_L	2	AGND
3	MIC2_R	4	AVCC
5	FRO_R	6	MIC2_JD
7	F_IO_SEN	8	N/C
9	FRO_L	10	LINE2_JD

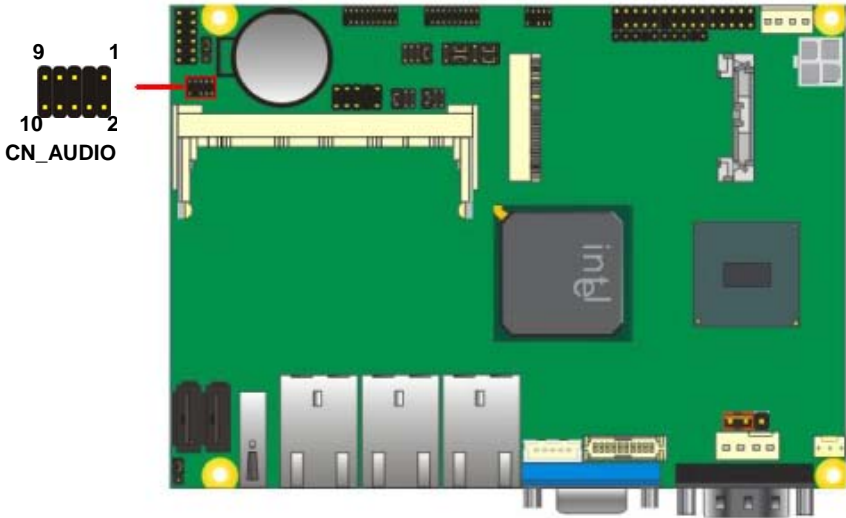

## 2.11 <USB2.0 Interface>

Based on Intel® ICH8M , the board provides 4 USB2.0 ports. The USB2.0 interface provides up to 480Mbps of transferring rate.

Interface	USB2.0
Controller	ICH8M
Transfer Rate	Up to 480Mb/s
Output Current	500mA

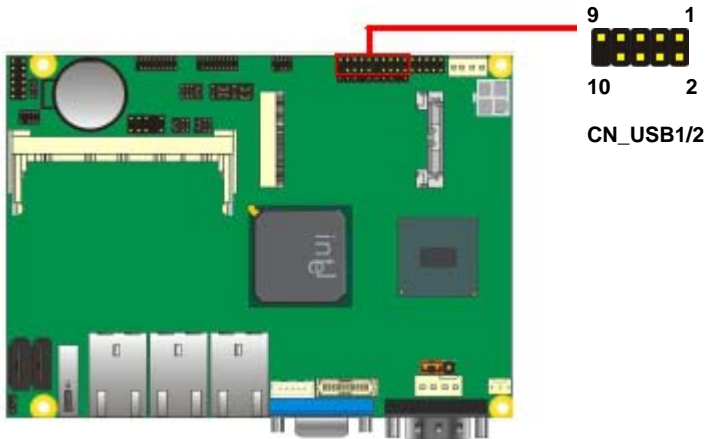

Connector: **CN\_USB**

Type: 10-pin (5 x 2) header for USB Port

Pin	Description	Pin	Description
1	VCC	2	VCC
3	Data0-	4	Data1-
5	Data0+	6	Data1+
7	Ground	8	Ground
9	Ground	10	N/C

PS: The USB2.0 will be only active when you connecting with the USB2.0 devices, if you insert an USB1.1 device, the port will be changed to USB1.1 protocol automatically. The transferring rate of USB2.0 as 480Mbps is depends on device capacity, exact transferring rate may not be up to 480Mbps.

## 2.12 <Serial Port Jumper Setting >

The board provides two RS232 serial ports, with jumper selectable RS422/485/IrDA for COM2.

Connector: **CN\_COM1**

Type: 9-pin D-sub male connector

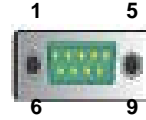

Pin	Description	Pin	Description
1	MDCD1-	6	MDSR1-
2	MSIN1-	7	MRTS1-
3	MSO1-	8	MCTS1-
4	MDTR1-	9	MRI1-
5	Ground		

Connector: **CN\_COM2**

Type: 9-pin header connector (pitch = 2.54x1.27 mm)

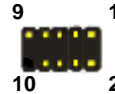

Pin	Description	Pin	Description
1	DCDBTXC-	2	SINBTXC
3	SOUTBRXC	4	DTRBRXC-
5	Ground	6	MDSR2-
7	MRTS2-	8	MCTS2-
9	MRI2-		

Connector: **CN\_COM3/4**

Type: 20-pin (10 x 2) 1.27mm x 2.54mm-pitch header for COM3/4

Pin	Description	Pin	Description
1	HS_DCD1-	2	HS_RXD1
3	HS_TXD1	4	HS_DTR1-
5	GND	6	HS_DSR1-
7	HS_RTS1-	8	HS_CTS1-
9	COM39	10	NC
11	HS_DCD2-	12	HS_RXD2
13	HS_TXD2	14	HS_DTR2-
15	GND	16	HS_DSR2-
17	HS_RTS2-	18	HS_CTS2-
19	COM49	20	NC









Connector: **CN\_COM5/6**

Type: 20-pin (10 x 2) 1.27mm x 2.54mm-pitch header for COM5/6

Pin	Description	Pin	Description
1	HS_DCD3-	2	HS_RXD3
3	HS_TXD3	4	HS_DTR3-
5	GND	6	HS_DSR3-
7	HS_RTS3-	8	HS_CTS3-
9	HS_RI3-	10	NC
11	HS_DCD4-	12	HS_RXD4
13	HS_TXD4	14	HS_DTR4-
15	GND	16	HS_DSR4-
17	HS_RTS4-	18	HS_CTS4-
19	HS_RI4-	20	NC

Jumper: **JCSEL1,JCSEL2**

Type: 12-pin (6 x 2) & 8-pin (4 x 2) for set COM2 mode jumper

Function	JCSEL2	JCSEL1
IrDA		
RS-422		
RS-485		
RS-232		

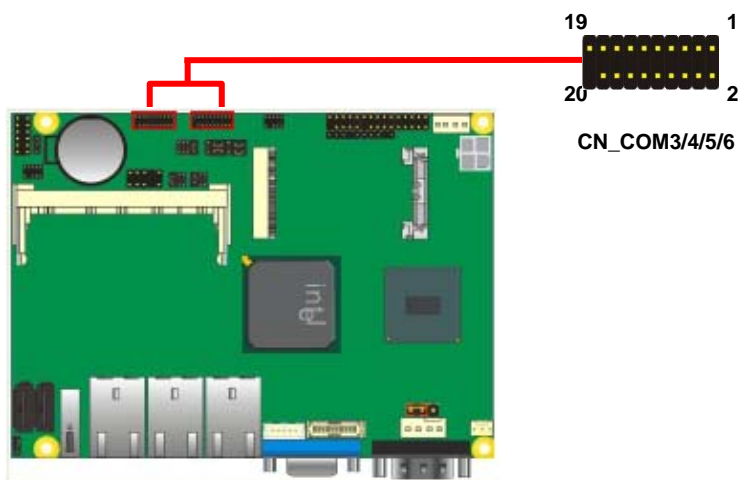
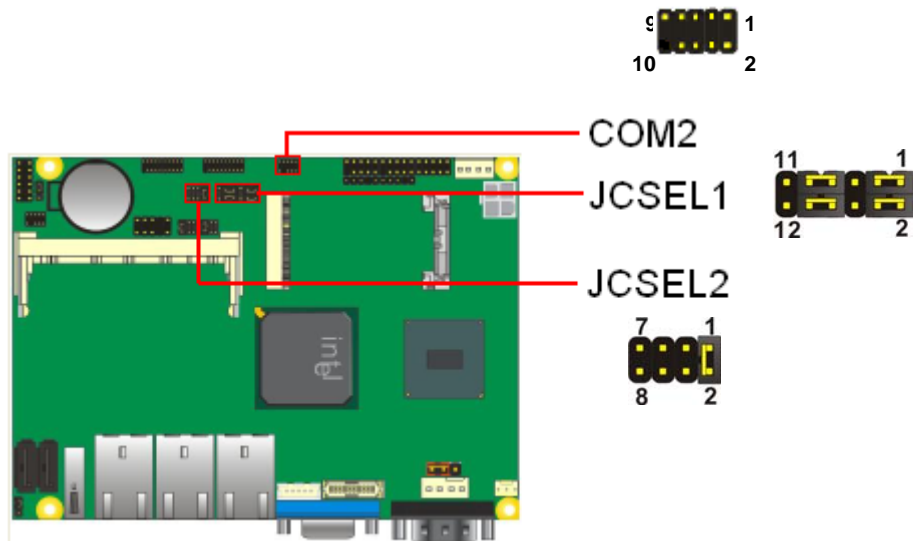

## 2.13 <Power & FAN Connector >

The board requires DC input with 4-pin header, the input voltage is 9V to 24V, for the input current, please take a reference of the power consumption report on appendix.

### 2.13.1 <Power Input>

Connector: DC\_IN

Type: 4-pin header

Pin	Description	Pin	Description
1	Ground	3	+12V
2	Ground	4	+12V

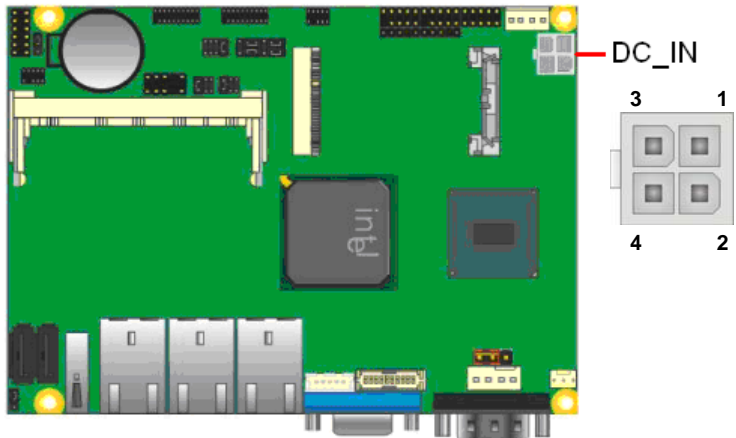

### 2.13.2 <Power Output>

Connector: **DC\_OUT**

Type: 4-pin connector for +5V/+12V output

Pin	Description
1	+12V
2	GND
3	GND
4	+5V

**Note:** Maximum output current **12V/1A, 5V/1A**

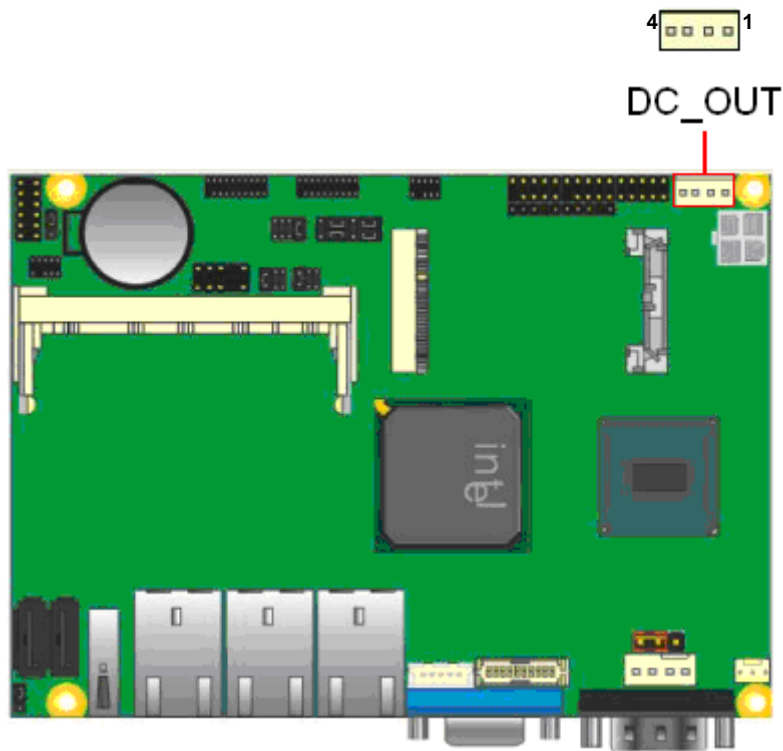

### 2.13.3 <Fan Connector>

Connector: **SYSFAN**

Type: 3-pin fan wafer connector

Pin	Description	Pin	Description	Pin	Description
1	Ground	2	+12V	3	CSFAN

Connector: **CPUFAN**

Type: 4-pin fan wafer connector

Pin	Description
1	Ground
2	+12V
3	P1FAN
4	+5V

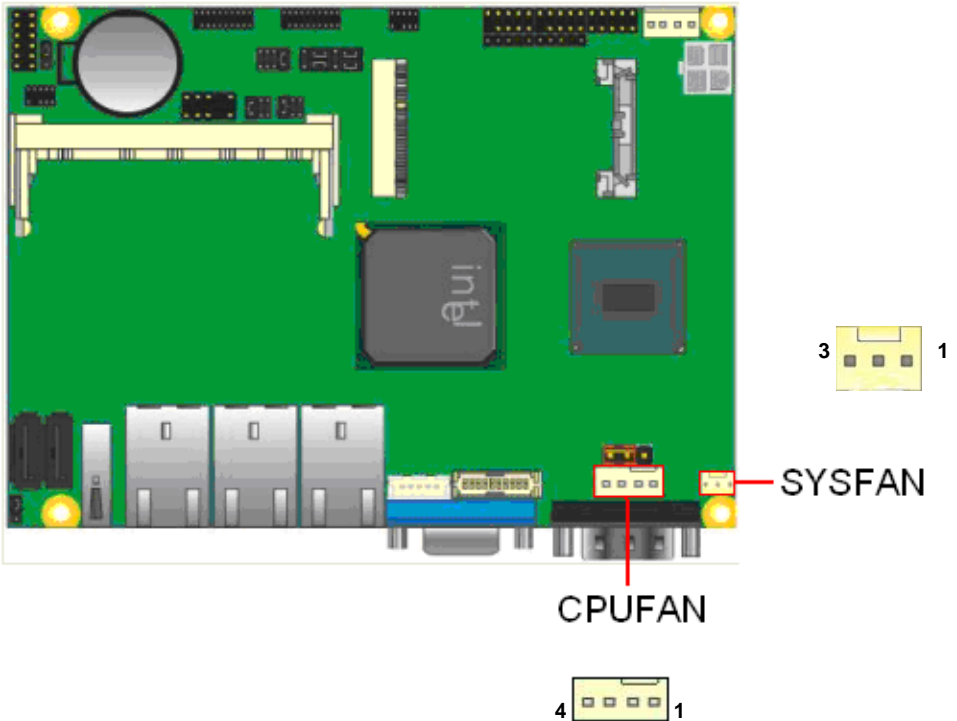

## 2.14 <Indicator and Switch>

The **JFRNT** provides front control panel of the board, such as power button, reset and beeper, etc. Please check well before you connecting the cables on the chassis.

Connector: **JFRNT**

Type: onboard 10-pin (2 x 5) 2.54-pitch header

Function	Signal	PIN		Signal
Power	PWRBT-	1	2	PWRBT+
Speaker	SPK-	3	4	SPK+
HDD LED	HLED-	5	6	HLED+
Power LED	GND	7	8	PWLED+
Reset	Reset-	9	10	GND

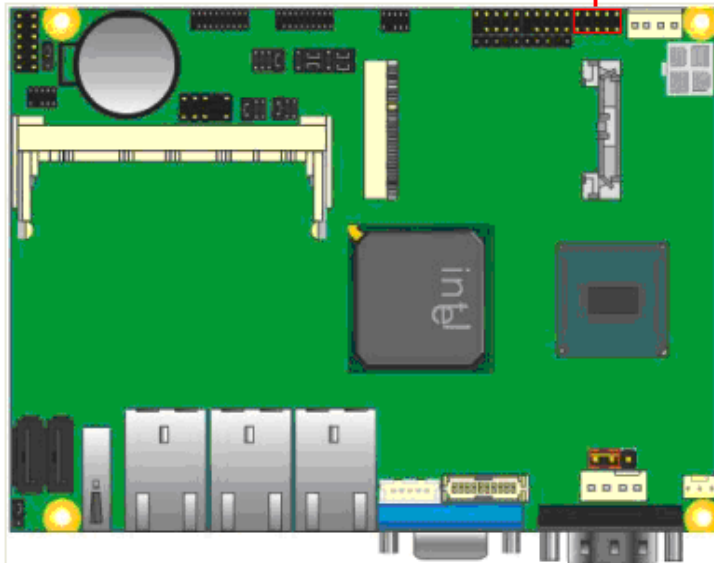
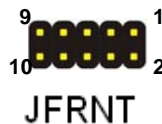

## Chapter 3 <BIOS Setup>

The motherboard uses the Award BIOS for the system configuration. The Award BIOS in the single board computer is a customized version of the industrial standard BIOS for IBM PC AT-compatible computers. It supports Intel® x86 and compatible CPU architecture based processors and computers. The BIOS provides critical low-level support for the system central processing, memory and I/O sub-systems.

The BIOS setup program of the single board computer let the customers modify the basic configuration setting. The settings are stored in a dedicated battery-backed memory, NVRAM, retains the information when the power is turned off. If the battery runs out of the power, then the settings of BIOS will come back to the default setting.

The BIOS section of the manual is subject to change without notice and is provided here for reference purpose only. The settings and configurations of the BIOS are current at the time of print, and therefore they may not be exactly the same as that displayed on your screen.

To activate CMOS Setup program, press <DEL> key immediately after you turn on the system. The following message "Press DEL to enter SETUP" should appear in the lower left hand corner of your screen. When you enter the CMOS Setup Utility, the Main Menu will be displayed as **Figure 4-1**. You can use arrow keys to select your function, press <Enter> key to accept the selection and enter the sub-menu.

**Figure 4-1** CMOS Setup Utility Main Screen

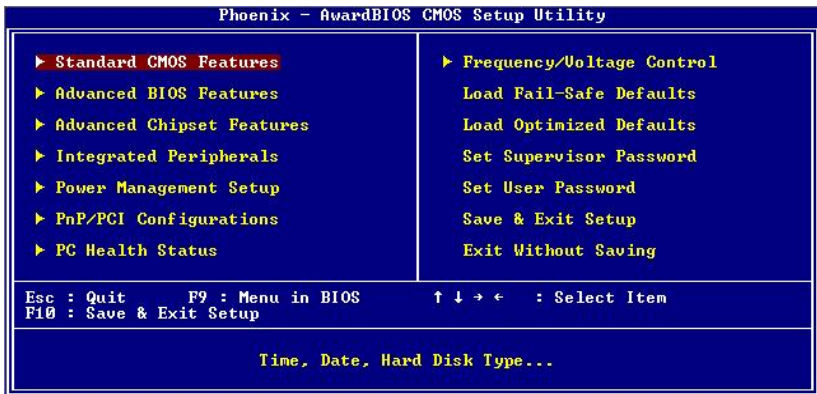

## Appendix A <I/O Port Pin Assignment>

### A.1 <LPT Port>

Connector: **CN\_LPT**

Type: 25-pin header for LPT Port



Pin	Description	Pin	Description
1	-PSTB	2	AFD-
3	PRD0	4	ERR-
5	PRD2	6	INIT-
7	PRD2	8	SLIN-
9	PRD3	10	Ground
11	PRD4	12	Ground
13	PRD5	14	Ground
15	PRD6	16	Ground
17	PRD7	18	Ground
19	ACK-	20	Ground
21	BUSY	22	Ground
23	PE	24	Ground
25	SLCT		

### A.2 <CRT Port >

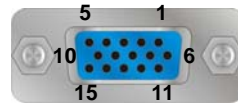

Connector: CRT

Type: 15-pin D-sub female connector on rear panel

Pin	Description	Pin	Description	Pin	Description
1	RED	6	Ground	11	N/C
2	GREEN	7	N/C	12	5VCD A
3	BLUE	8	Ground	13	5HSYNC
4	N/C	9	N/C	14	5VSYNC
5	-CRTATCH	10	-CRTATCH	15	5VCLK

### A.3 <LAN Port>

Connector: **RJ45**

Type: RJ45 connector with LED on rear panel

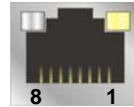

Pin	1	2	3	4	5	6	7	8
Description	TRD0+	TRD0-	TRD1+	TRD2+	TRD2-	TRD1-	TRD3+	TRD3-

### A.4 <IrDA Port>

Connector: **CN\_IR**

Type: 5-pin header for SIR Port



Pin	Description
1	+5V
2	N/C
3	IRRXD
4	Ground
5	IRTXD

### A.5 <SMBUS Port>

Connector: **CN\_SMBUS**

Type: 5-pin header for SMBUS Port



Pin	Description
1	+5V
2	N/C
3	SMDATA
4	SMCLK
5	Ground

## A.6 <Serial Port>

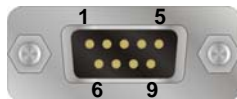

Connector: **COM1**

Type: 9-pin D-sub male connector on rear panel

Pin	Description	Pin	Description
1	MDCD1-	6	MDSR1-
2	MSIN1-	7	MRTS1-
3	MSO1-	8	MCTS1-
4	MDTR1-	9	MRI1-
5	Ground		

## A.7 <DIO Port>

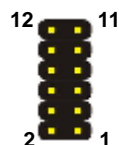

Connector: **CN\_DIO**

Type: 12-pin D-sub male connector on rear panel

Pin	Description	Pin	Description
1	Ground	7	GP12
2	Ground	8	GP16
3	GP10	9	GP13
4	GP14	10	GP17
5	GP11	11	+5V
6	GP15	12	+12V

## A.8 <PS2 Port>



Connector: **CN\_PS2**

Type: 10-pin D-sub male connector on rear panel

Pin	Description	Pin	Description
1	KBDA	6	Ground
2	MDA	7	BVCC
3	N/C	8	BVCC
4	N/C	9	KBCL
5	Ground	10	MCL

## Appendix B <Flash BIOS>

### B.1 BIOS Auto Flash Tool

The board is based on Award BIOS and can be updated easily by the BIOS auto flash tool. You can download the tool online at the address below:

<http://www.award.com>

<http://www.commell.com.tw/support/support.htm>

File name of the tool is "awdfash.exe", it's the utility that can write the data into the BIOS flash ship and update the BIOS.

### B.2 Flash Method

1. Please make a bootable floppy disk.
2. Get the last .bin files you want to update and copy it into the disk.
3. Copy awardflash.exe to the disk.
4. Power on the system and flash the BIOS. (Example: C:/ awardflash XXX.bin)
5. Re-star the system.

Any question about the BIOS re-flash please contact your distributors or visit the web-site at below:























<http://www.commell.com.tw/support/support.htm>



























## Appendix C <System Resources>

### C.1 <Direct memory access(DMA)> (LE-376A)































 4 Direct memory access controller

### C.2<Input/output(IO)> (LE-376A)







































	[00000000 - 0000000F]	Direct memory access controller
	[00000000 - 00000CF7]	PCI bus
	[00000010 - 0000001F]	Motherboard resources
	[00000020 - 00000021]	Programmable interrupt controller
	[00000022 - 0000003F]	Motherboard resources
	[00000040 - 00000043]	System timer
	[00000044 - 0000005F]	Motherboard resources
	[00000060 - 00000060]	Standard 101/102-Key or Microsoft Natural PS/2 Keyboard
	[00000061 - 00000061]	System speaker
	[00000062 - 00000063]	Motherboard resources
	[00000064 - 00000064]	Standard 101/102-Key or Microsoft Natural PS/2 Keyboard
	[00000065 - 0000006F]	Motherboard resources
	[00000070 - 00000073]	System CMOS/real time clock
	[00000074 - 0000007F]	Motherboard resources
	[00000080 - 00000090]	Direct memory access controller
	[00000091 - 00000093]	Motherboard resources
	[00000094 - 0000009F]	Direct memory access controller
	[000000A0 - 000000A1]	Programmable interrupt controller
	[000000A2 - 000000BF]	Motherboard resources
	[000000C0 - 000000DF]	Direct memory access controller
	[000000E0 - 000000EF]	Motherboard resources
	[000000F0 - 000000FF]	Numeric data processor
	[000001F0 - 000001F7]	Primary IDE Channel
	[00000274 - 00000277]	ISAPNP Read Data Port
	[00000279 - 00000279]	ISAPNP Read Data Port
	[00000280 - 00000287]	Communications Port (COM5)
	[00000288 - 0000028F]	Communications Port (COM6)
	[000002A0 - 000002A7]	Communications Port (COM3)
	[000002A8 - 000002AF]	Communications Port (COM4)
	[000002F8 - 000002FF]	Built-in Infrared Device
	[00000378 - 0000037F]	Printer Port (LPT1)
	[000003B0 - 000003BB]	Intel(R) Graphics Media Accelerator 3150
	[000003C0 - 000003DF]	Intel(R) Graphics Media Accelerator 3150
	[000003F6 - 000003F6]	Primary IDE Channel
	[000003F8 - 000003FF]	Communications Port (COM1)

-  [00000400 - 000004BF] Motherboard resources
-  [000004D0 - 000004D1] Motherboard resources
-  [00000500 - 0000051F] Intel(R) ICH8 Family SMBus Controller - 283E
-  [00000778 - 0000077B] Printer Port (LPT1)
-  [00000880 - 0000088F] Motherboard resources
-  [00000A79 - 00000A79] ISAPNP Read Data Port
-  [00000D00 - 0000FFFF] PCI bus
-  [0000C000 - 0000CFFF] Intel(R) ICH8 Family PCI Express Root Port 3 - 2843
-  [0000CF00 - 0000CF1F] Intel(R) 82583V Gigabit Network Connection #3
-  [0000D000 - 0000DFFF] Intel(R) ICH8 Family PCI Express Root Port 2 - 2841
-  [0000DF00 - 0000DF1F] Intel(R) 82583V Gigabit Network Connection #2
-  [0000E000 - 0000EFFF] Intel(R) ICH8 Family PCI Express Root Port 1 - 283F
-  [0000EF00 - 0000EF1F] Intel(R) 82583V Gigabit Network Connection
-  [0000F300 - 0000F30F] Intel(R) ICH8M 3 port Serial ATA Storage Controller - 2828
-  [0000F400 - 0000F40F] Intel(R) ICH8M 3 port Serial ATA Storage Controller - 2828
-  [0000F500 - 0000F503] Intel(R) ICH8M 3 port Serial ATA Storage Controller - 2828
-  [0000F600 - 0000F607] Intel(R) ICH8M 3 port Serial ATA Storage Controller - 2828
-  [0000F700 - 0000F703] Intel(R) ICH8M 3 port Serial ATA Storage Controller - 2828
-  [0000F800 - 0000F807] Intel(R) ICH8M 3 port Serial ATA Storage Controller - 2828
-  [0000F900 - 0000F90F] Intel(R) ICH8M Ultra ATA Storage Controllers - 2850
-  [0000FA00 - 0000FA1F] Intel(R) ICH8 Family USB Universal Host Controller - 2832
-  [0000FB00 - 0000FB1F] Intel(R) ICH8 Family USB Universal Host Controller - 2831
-  [0000FC00 - 0000FC1F] Intel(R) ICH8 Family USB Universal Host Controller - 2830
-  [0000FD00 - 0000FD1F] Intel(R) ICH8 Family USB Universal Host Controller - 2835
-  [0000FE00 - 0000FE1F] Intel(R) ICH8 Family USB Universal Host Controller - 2834
-  [0000FF00 - 0000FF07] Intel(R) Graphics Media Accelerator 3150

### C.3<Interrupt request(IRQ)> (LE-376A)

	(ISA) 0	High precision event timer
	(ISA) 1	Standard 101/102-Key or Microsoft Natural PS/2 Keyboard
	(ISA) 3	Built-in Infrared Device
	(ISA) 4	Communications Port (COM1)
	(ISA) 5	Communications Port (COM3)
	(ISA) 7	Communications Port (COM4)
	(ISA) 8	High precision event timer
	(ISA) 9	Microsoft ACPI-Compliant System
	(ISA) 10	Communications Port (COM5)
	(ISA) 11	Communications Port (COM6)
	(ISA) 13	Numeric data processor
	(ISA) 14	Primary IDE Channel
	(PCI) 15	Intel(R) ICH8 Family SMBus Controller - 283E
	(PCI) 16	Intel(R) 82583V Gigabit Network Connection
	(PCI) 16	Intel(R) Graphics Media Accelerator 3150
	(PCI) 16	Intel(R) ICH8 Family PCI Express Root Port 1 - 283F
	(PCI) 16	Intel(R) ICH8 Family PCI Express Root Port 5 - 2847
	(PCI) 16	Intel(R) ICH8 Family USB Universal Host Controller - 2834
	(PCI) 17	Intel(R) 82583V Gigabit Network Connection #2
	(PCI) 17	Intel(R) ICH8 Family PCI Express Root Port 2 - 2841
	(PCI) 18	Intel(R) 82583V Gigabit Network Connection #3
	(PCI) 18	Intel(R) ICH8 Family PCI Express Root Port 3 - 2843
	(PCI) 18	Intel(R) ICH8 Family USB Universal Host Controller - 2832
	(PCI) 18	Intel(R) ICH8 Family USB2 Enhanced Host Controller - 283A
	(PCI) 19	Intel(R) ICH8 Family USB Universal Host Controller - 2831
	(PCI) 19	Intel(R) ICH8M 3 port Serial ATA Storage Controller - 2828
	(PCI) 21	Intel(R) ICH8 Family USB Universal Host Controller - 2835
	(PCI) 22	Microsoft UAA Bus Driver for High Definition Audio
	(PCI) 23	Intel(R) ICH8 Family USB Universal Host Controller - 2830
	(PCI) 23	Intel(R) ICH8 Family USB2 Enhanced Host Controller - 2836

## C.4<Memory> (LE-376A)

	[00000000 - 0009FFFF] System board
	[000A0000 - 000BFFFF] Intel(R) Graphics Media Accelerator 3150
	[000A0000 - 000BFFFF] PCI bus
	[000C0000 - 000DFFFF] PCI bus
	[000E0000 - 000EFFFF] System board
	[000F0000 - 000FFFFF] System board
	[00100000 - BF58FFFF] System board
	[BF590000 - BF5FFFFF] System board
	[BF600000 - BF6FFFFF] System board
	[BF700000 - FEBFFFFF] PCI bus
	[D0000000 - DFFFFFFF] Intel(R) Graphics Media Accelerator 3150
	[E0000000 - EFFFFFFF] Motherboard resources
	[FD300000 - FD3FFFFF] Intel(R) ICH8 Family PCI Express Root Port 1 - 283F
	[FD400000 - FD4FFFFF] Intel(R) ICH8 Family PCI Express Root Port 1 - 283F
	[FD4C0000 - FD4DFFFF] Intel(R) 82583V Gigabit Network Connection
	[FD4FC000 - FD4FFFFF] Intel(R) 82583V Gigabit Network Connection
	[FD700000 - FD7FFFFF] Intel(R) Graphics Media Accelerator 3150
	[FD800000 - FD8FFFFF] Intel(R) ICH8 Family PCI Express Root Port 5 - 2847
	[FD900000 - FD9FFFFF] Intel(R) ICH8 Family PCI Express Root Port 5 - 2847
	[FDA00000 - FDAFFFFF] Intel(R) ICH8 Family PCI Express Root Port 3 - 2843
	[FDB00000 - FDBFFFFF] Intel(R) ICH8 Family PCI Express Root Port 3 - 2843
	[FDBC0000 - FDBDFFFF] Intel(R) 82583V Gigabit Network Connection #3
	[FDBFC000 - FDBFFFFF] Intel(R) 82583V Gigabit Network Connection #3
	[FDC00000 - FDCFFFFF] Intel(R) ICH8 Family PCI Express Root Port 2 - 2841
	[FDD00000 - FDDFFFFF] Intel(R) ICH8 Family PCI Express Root Port 2 - 2841
	[FDDC0000 - FDDDFFFF] Intel(R) 82583V Gigabit Network Connection #2
	[FDDFC000 - FDDFFFFF] Intel(R) 82583V Gigabit Network Connection #2
	[FDE80000 - FDEFFFFF] Intel(R) Graphics Media Accelerator 3150
	[FDFF8000 - FDFFBFFF] Microsoft UAA Bus Driver for High Definition Audio
	[FDFFD000 - FDFFD0FF] Intel(R) ICH8 Family SMBus Controller - 283E
	[FDFFE000 - FDFFE3FF] Intel(R) ICH8 Family USB2 Enhanced Host Controller - 2836
	[FDFFF000 - FDFFF3FF] Intel(R) ICH8 Family USB2 Enhanced Host Controller - 283A
	[FEB80000 - FEBFFFFF] Intel(R) Graphics Media Accelerator 3150
	[FEC00000 - FEC00FFF] System board
	[FED00000 - FED000FF] System board
	[FED00000 - FED003FF] High precision event timer
	[FED13000 - FED1FFFF] System board
	[FED20000 - FED9FFFF] System board
	[FEE00000 - FEE00FFF] System board
	[FFB00000 - FFB7FFFF] System board
	[FFB80000 - FFBFFFFF] Intel(R) 82802 Firmware Hub Device
	[FFF00000 - FFFFFFFF] System board

## Appendix E <Watch Dog timer Setting >

The watchdog timer makes the system auto-reset while it stops to work for a period. The integrated watchdog timer can be setup as system reset mode by program.

### Timeout Value Range

- 1 to 255
- Second or Minute

### Program Sample

Watchdog timer setup as system reset with 5 second of timeout

---

```

2E, 87
2E, 87
2E, 07
2F, 08      Logical Device 8
2E, 30
2F, 01      Activate
2E, F5
2F, 00      Set as Second*
2E, F6
2F, 05      Set as 5
    
```

---

\* Minute: bit 3 = 1; Second: bit 3 = 0

You can select Timer setting in the BIOS, after setting the time options, the system will reset according to the period of your selection.



## Contact Information

Any advice or comment about our products and service, or anything we can help you please don't hesitate to contact with us. We will do our best to support you for your products, projects and business.

### Taiwan Commate Computer Inc.

---

Address	19 F No. 94, Sec. 1, Shin Tai Wu Rd., Shi Chih Taipei Hsien, Taiwan
TEL	+886-2-26963909
FAX	+886-2-26963911
Website	<a href="http://www.commell.com.tw">http://www.commell.com.tw</a>
E-Mail	<a href="mailto:info@commell.com.tw">info@commell.com.tw</a> (General Information) <a href="mailto:tech@commell.com.tw">tech@commell.com.tw</a> (Technical Support)

---

**Commell is our trademark of industrial PC division**